

Goodmans

GPSI65MP3R

INSTRUCTION MANUAL



**PORTABLE CD/MP3 PLAYER WITH STEREO RADIO
CASSETTE RECORDER**

Please read these instructions before use and keep for future reference

WARNING: UNDER NO CIRCUMSTANCES MUST THE LIVE OR NEUTRAL WIRES BE CONNECTED TO THE EARTH TERMINAL IN 3-PIN MAINS PLUG.



This symbol means that this unit is double insulated.

An earth connected is not required.

CAUTION: The power switch is the TAPE function switch located on top left side of the player. When operating from 230V mains supply this does not completely disconnect the unit from the mains supply. Please be assured that it is perfectly safe to leave the unit connected to the mains supply.

CAUTION

CLEANING: Ways disconnect the unit from mains supply before attempting to clean it.

Use soft cloth moistened with soap water, wipe gently.

Do not use solvents or abrasive materials.

* Save the carton and packing materials: they will be useful if you ever have to transport the unit.

Electrical Information

This appliance is fitted with a BSI363/A 13 amp plug. If it is not suitable for your supply sockets, it must be removed and replaced with an appropriate plug. If the plug becomes damaged and/or needs to be replaced, please follow the wiring instructions below. The plug removed must be disposed of immediately. It must not be plugged into a supply socket as this will be an electrical hazard.

If the fuse needs to be replaced, it must be of the same rating and ASTA approved to BS1362. If the plug is changed, a fuse of the appropriate rating must be fitted in the plug, adapter or at the distribution board. If the fuse in a moulded plug is replaced, the fuse cover must be refitted before the appliance can be used.

Wiring instructions

The supply cable will be either 2-core or 3-core. Follow the appropriate wiring instructions given below. In both cases ensure that the outer sheath of the cable is firmly held by the cable clamp.

2 - CORE

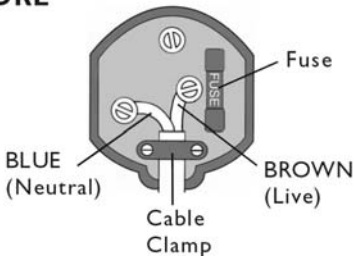

WARNING! Do not connect either wire to the earth terminal.

This symbol indicates that this 2-core appliance is Class II and does not require an earth connection.

The wire coloured blue must be connected to the terminal marked with the letter N or coloured black.

3 - CORE

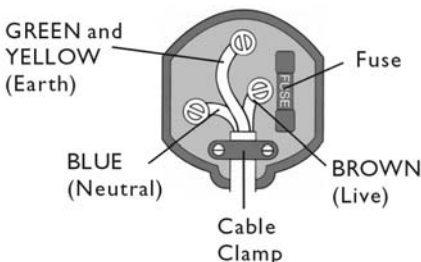

WARNING! This appliance must be earthed.

The wire coloured green and yellow must be connected to the terminal marked with the letter E, or by the earth symbol, \perp , or coloured green or green and yellow.

The wire coloured blue must be connected to the terminal marked with the letter N or coloured black.

The wire coloured brown must be connected to the terminal marked with the letter L or coloured red.

FUNCTIONS AND CONTROLS

1. CD DOOR OPEN/CLOSE
2. FUNCTION SWITCH
3. FM STEREO INDICATOR
4. VOLUME CONTROL
5. CD FOLD-/-10 BUTTON
6. CD PROG./P-MODE BUTTON
7. PHONES SOCKET
8. CD STOP BUTTON
9. CASSETTE PAUSE KEY
10. CASSETTE STOP/EJECT KEY
11. CASSETTE FAST FORWARD KEY
12. CASSETTE REWIND KEY
13. CASSETTE PLAY KEY
14. CASSETTE RECORD KEY
15. CD SKIP/SEARCH
BACKWARD BUTTON
16. DBBS ON/OFF BUTTON
17. CD SKIP/SEARCH
FORWARD BUTTON
18. CD FOLD+/+10 BUTTON
19. TUNING KNOB
20. CD PLAY/PAUSE BUTTON
21. BAND SELECTOR
22. CD COMPARTMENT
23. HANDLE
24. SPEAKERS
25. CASSETTE DOOR
26. CD DISPLAY
27. REMOTE SENSOR
28. BATTERY DOOR
29. AC SOCKET
30. FM ANTENNA
31. POWER INDICATOR
32. BUILT-IN CONDENSER MIC

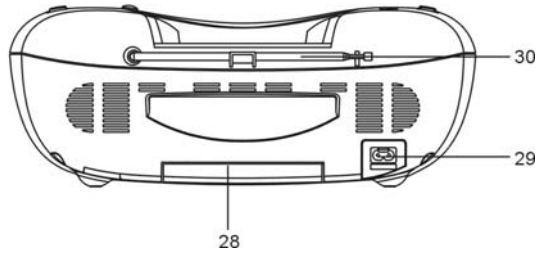
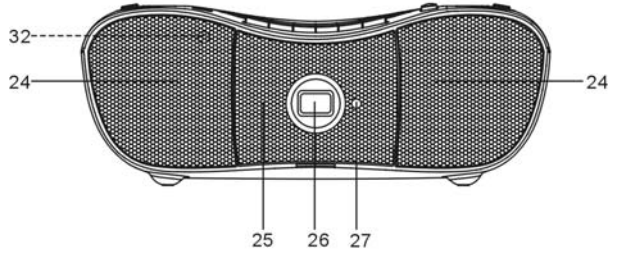
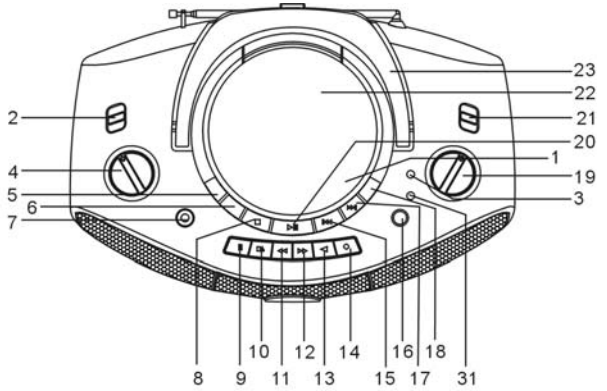

IMPORTANT NOTES

INTRODUCTION

- Thank you for buying our product.
- Please read through these operating instructions, so you will know how to operate your equipment properly. After you finished reading the instructions manual, put it away in a safe place for future reference.

WARNING

To prevent fire or shock hazard, do not expose this appliance to rain or moisture. To avoid electrical shock, do not open the cabinet; refer servicing to qualified personnel only.

CAUTION

Use of controls or adjustment or performance of procedures other than those specified herein may result in hazardous radiation exposure.

DANGER

Invisible laser radiation when open and interlock failed or defeated. Avoid direct exposure to beam.

CLASS I LASER PRODUCT

This Compact Disc player is classified as a Class I LASER PRODUCT. THE CLASS I LASER PRODUCT label is located on the rear exterior.

- Avoid installing the unit in locations described below:
 1. Places exposed to direct sunlight or close to heat radiating appliance such as electric heaters, on top of other stereo equipment that radiate too much heat.
 2. Places lacking ventilation or dusty places.
 3. Places subject to constant vibration.
 4. Humid or moist places.
- Operate turning controls and switches as instructed in manual.
- Before turning on the power for the first time, make sure that the power cord is properly installed.
- Store your tapes or CD in a cool area to avoid damage from heat.

CAUTION: TO REDUCE THE RISK OF ELECTRIC SHOCK, DO NOT REMOVE COVER (OR BACK). NO USER SERVICEABLE PARTS INSIDE, REFER SERVICING TO QUALIFIED SERVICE PERSONNEL.

WARNING: Remove batteries if exhausted or if they will not be used again for a long period.

The incorrect use of batteries can cause electrolyte leakage and will corrode the compartment or cause the batteries to burst, therefore:

Do not mix battery types, e.g. alkaline with zinc carbonate.

When inserting new batteries, replace all batteries at the same time.

REMOTE CONTROLLER

You can control the system with the provided remote controller. Slide open and insert two (AA / UM3) batteries correctly so that the + and – polarities match the polarity diagrams inside the battery compartment.

- When the batteries are exhausted, the remote will no longer operate the system. Replace both batteries with new ones.
- When the remote is not to be used for a long time, remove the batteries to avoid damage caused by battery leakage and corrosion.
- Avoid keeping the remote in extremely hot or humid locations.
- Between remote controller and remote sensor there should be on no obstacles in the way. The remote range is approx 8 Metres.

REMOTE CONTROL FUNCTIONS

1. P-MODE BUTTON
2. PROGRAM BUTTON
3. NUMERIC BUTTONS
4. --- BUTTON
5. BATTERY COMPARTMENT
6. FOLDER+ BUTTON
7. SKIP FORWARD BUTTON
8. SKIP BACKWARD BUTTON
9. STOP BUTTON
10. PLAY/PAUSE BUTTON

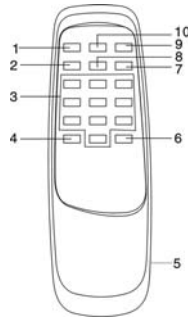

POWER SUPPLY

1. BATTERY OPERATION

(Batteries are not supplied)

- REMOVE THE BATTERY COMPARTMENT DOOR.
- INSERT 8 PIECES UM-2 (C SIZE) BATTERIES INTO THE BATTERY COMPARTMENT WITH BATTERY POLARITY POSITIONED AS INDICATED.
NOTE: WE RECOMMEND THE USE OF ALKALINE BATTERIES.
- CLOSE THE BATTERY COMPARTMENT DOOR.

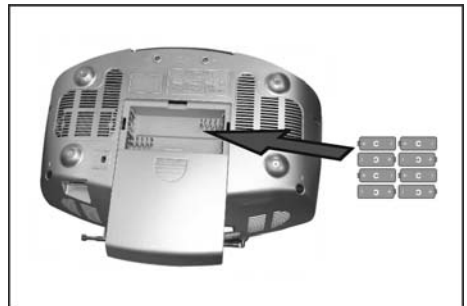

2. AC OPERATION

- PLUG THE AC LINE CORD INTO ANY NORMAL HOUSEHOLD AS MAINS OUTLET IN CORRECT VOLTAGE AND THE MAINS SOCKET.
- THE BATTERIES WILL BE AUTOMATICALLY DISCONNECTED.
- FOR MAINS OPERATION CONNECT THE SUPPLIED AC CORD TO THE AC SOCKET ON THE LEFT REAR OF THE UNIT. CONNECT THE 3 PIN MAINS PLUG TO A 3 PIN 230VAC MAINS SOCKET.

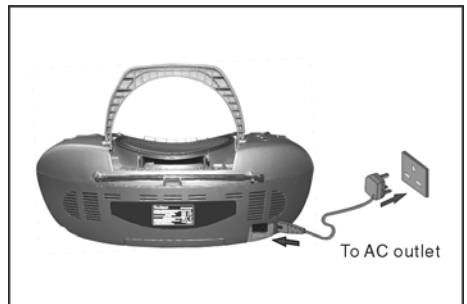

RADIO OPERATION

Set FUNCTION SWITCH to "RADIO" position.

FM/FM ST. BAND

Select FM ST. mode by band selector switch. Turn the TUNING control to select the desired station. The FM stereo indicator will light up which shows a FM stereo broadcast is being received, fully extend the FM antenna and adjust its direction for best FM reception. If the FM broadcast signal is weak, slide the switch to "FM" position to turn off the FM stereo, FM stereo indicator will disappear and the background noise will be reduced. After use set the function selector switch back to Off/Tape position.

MW BAND

Select MW mode by band selector switch. Turn the TUNING control to select the desired station. The MW aerial is fitted internally and is highly directional. Rotate the set for best reception. After use move the function selector switch back to the Off/Tape position.

CASSETTE OPERATION

PLAYBACK OF CASSETTE

Be sure to tighten any slack tape in the cassette before use, using either a pencil or a ballpoint pen, simply insert the pen or pencil into the centre of spool and rotate to remove slacks. Depress the STOP/EJECT button to open the cassette door.

Insert the cassette into the compartment with the open end facing upwards and the full reel on the left hand side, push the cassette well down and close the door; be sure not to touch the tape surface, Set the Function switch to "TAPE" position and press the cassette play button. To stop playback, press the STOP/EJECT button once. To release the cassette, press the STOP/EJECT button again.

AUTO STOP

When the tape reaches the end during playback or recording, the built-in auto stop system will release the depressed play, record keys. The auto stop system operates while recording from the built-in radio or CD player, only the cassette function is brought automatically to stop mode and the radio or CD player will continue to play.

RADIO RECORDING

- A. Install blank cassette tape.
- B. Set FUNCTION SWITCH to "RADIO" position. After selecting the desired band and tune the TUNING KNOB to desired broadcast station. Then push down RECORD BUTTON and PLAY BUTTON simultaneously.
- C. After recording the desired broadcast, depress the STOP/EJECT BUTTON lightly, and then set FUNCTION SWITCH to "TAPE" position in order to listen to the recorded broadcast.
- D. Press REW button then play button to playback your recording.

ERASURE: When you record over previously recorded tape, the original recording is automatically erased and replaced by the new recording.

CD/MP3 RECORDING

- A. Install a blank tape into cassette compartment.
- B. Set the FUNCTION switch to "CD/MP3" position. Load a disc into the disc compartment, start playback by pressing the CD PLAY/PAUSE button after the unit finished reading the disc.
- C. Depress the RECORD BUTTON and PLAY BUTTON simultaneously. Recording starts. Press the STOP/EJECT BUTTON lightly to end recording, or the unit will stop recording automatically while the tape reaches its end.
- D. To listen to the recording, set the FUNCTION switch to select "TAPE" playing mode, then start tape playback.

RECORDING FROM BUILT-IN MIC

1. Set the Function Switch to "TAPE" normal position.
2. Insert a blank cassette tape into the tape deck.
3. Press the RECORD key and the PLAY key simultaneously. You can start the recording through the built-in MIC.
4. To stop the recording manually, press the Stop/Eject Button.

TYPES OF CASSETTE

Use only good quality cassettes (IEC TYPE I) for making recordings. May be used to replay other types of cassette but is unable to make proper recording on these more specialized tapes.

The use of C120 cassettes is NOT recommended in this machine.

PROTECTING RECORDING

Normally, anything recorded on the tape is automatically erased when new recording is made. It is possible to protect your recording from accidental erasure by removing the tabs found on the rear of the cassette.



ERASE TAB
FOR SIDE "A"

When the cassette is held with the recorded side upper-most and exposed tape facing the front, the protective tab will be found on the left rear of the cassette.

All pre-recorded cassette are protected in this way to prevent accidental erasure of the commercial recording. "Protected" cassette will prevent the record button from being operated. If at any time you attempt to record and find that this button will not depress, never force the mechanism or it may be damaged. Check that a cassette has been loaded and that tab has not been removed. Recording on a cassette from which the tabs have been removed can be done by covering the tab openings with a piece of adhesive tape.

CARE OF CASSETTE MECHANISM

Use a cassette cleaning tape to clean the tape heads and mechanism. These are available from most high street audio specialist.

USING THE CD/MP3

Discs for Playback

This system can playback all digital audio CD/MP3/WMA discs, finalized digital audio CD-Recordable (CD-R) discs and finalized digital audio CD-Rewritable (CD-RW) discs.

LOADING A DISC

1. Set the FUNCTION switch to CD/MP3 position.
2. Open the CD door: "OP" will be shown on the display.
3. Place an audio CD/MP3 into the tray with the label side facing up.
4. Close the CD door. The total number of tracks and the disc type will appear on the display after several seconds.
5. To remove the CD, press CD DOOR OPEN/CLOSE to open CD compartment lid, grasp the CD by its edges, and carefully take it out.

Note:

- To ensure good system performance; wait until the disc tray completely reads the disc before proceeding.
- If no disc is loaded into the compartment, or the disc is placed upside down, the display will show "NO D".

Playing A Disc

1. Press the PLAY/PAUSE button to start playback, the playback starts from track 1, "▶" will appear on the display. Adjust the volume by the VOLUME knob.
2. To interrupt playback, press the PLAY/PAUSE button, "▶" and the track number will flash on the display.
3. To resume playback, press the PLAY/PAUSE button again.
4. To stop playback, press the STOP button, the total number of tracks appears on the display.

Selecting A Different Track During Play

1. Press CD SKIP/SEARCH FORWARD/BACKWARD button continuously until the desired track number appears in the display.
2. Playback starts from the desired track. (Press CD PLAY/PAUSE button to start playback in stop mode).

Starting Again With the Track That Is Currently Playing

1. Press CD SKIP/SEARCH BACKWARD button once.
2. The playback will start again from the beginning of the track.



Stopping Play

1. Press CD STOP button if you wish to stop play. The total track number which can be played will now appear on the display.
2. Open the CD door on the unit to remove the CD.



REPEAT

You can play one track or all tracks on the disc repeatedly.



To Repeat a Single Track

1. Press the PROG./P-MODE button once in play, "  " shows flashing on the display. The current track will be played over and over again till you press the STOP button.
2. To cancel repeat play, press PROG./P-MODE button until "  " disappears from display.

To repeat all the Tracks

1. Press PROG./P-MODE button twice in play, "  " shows steady on the display, all tracks on the disc will be played over and over again till you press the STOP button.
2. To cancel repeat play, press the PROG./P-MODE button until "  " disappears from the display.

To repeat the Folder (only for MP3 disc which contains more than one folder)

1. Press the PROG./P-MODE button thrice in play, "  FOLDER" shows steady on the display, the folder which is currently being played will be repeated over and over again till you press the STOP button.
 2. To cancel repeat play, press the PROG./P-MODE button until "  FOLDER" disappears from the display.
- Note: Press and hold the PROG./P-MODE button during playback, the display will show track and folder number cyclically release to show track.

PROGRAM TRACKS

Programming tracks of disc are possible when playback is stopped. Up to CD 20 tracks /MP3 99 tracks can be stored in the memory in any order.

1. In stop mode, press the PROG./P-MODE button, the PROG will flash and the PO1 will show on the display.
2. Press the CD SKIP/SEARCH FORWARD button to select the first desired track to be programmed.
3. Press the PROG./P-MODE button to enter. The display changes to show PO2.
4. Repeat steps 2 & 3 to store other desired tracks until all tracks are programmed.
5. Press the PLAY/PAUSE button to start playback from the first programmed track.
6. Press the STOP button to stop program playback.

To Erase the Memory (Program)

To clear the program, you have two options:

1. Press STOP button until "PROG" disappears on the display, or
2. Open the CD compartment lid, program will be erased.

RANDOM PLAY

Press the PROG./P-MODE button three times during play, "RDM" appears on the display, the unit will stop to search a track (song) randomly and start playback from this track, then select another in random order until all tracks are played over and then stop. To cancel random function, press the PROG./P-MODE button until the "RDM" indicator disappear on CD display.

INTROSCAN PLAY (for CD disc only)

Press the PROG./P-MODE button in four times during play, "INTRO" shows steady on the display, the unit will start to play the first 10 seconds of music of each track, until all tracks are played over and then stop. To cancel random function, press the PROG./P-MODE button until the "INTRO" indicator disappear on CD display.

TO SELECT A SONG WHICH TRACK NUMBER EXCEEDS 10 (for MP3 only)

To select a song/track which number exceeds 10, use the FOLD±/±10 buttons and the CD SKIP/SEARCH FORWARD/BACKWARD button. Press and HOLD the FOLD±/±10 buttons for about two seconds each time to skip forward/backward 10 tracks, then press the CD SKIP/SEARCH FORWARD/BACKWARD button to select desired track.

Note: Pressing and HOLDING the FOLD±/±10 buttons can skip at 10 tracks in succession.

HEADPHONE SOCKET

For private listening, plug a 3.5mm headphone (not included) into the PHONES SOCKET. The speaker output is automatically cut off.

BASS BOOST SYSTEM

The DBBS BUTTON controls the bass of the unit. Bass sound is the lower frequency ranges of sound. The knob can be pushed to OFF or ON position, When the DBBS is on, the unit boosts (increases) the sound output of the bass frequencies.

COMPACT DISC MAINTENANCE

1. Always use a compact disc bearing the mark as shown.



2. Notes on handing discs

- Removing the disc from its storage case and loading it.
- Do not touch the reflective recorded surface.
- Do not stick paper or write anything on the surface.
- Do not bend the disc.

3. Storage

- Store the disc in its case.
- DO not expose discs to direct sunlight or high temperatures, high humidity or dusty places.

4. Cleaning a disc

- Should the disc become soiled, wipe off dust, dirt and fingerprints with a soft cloth.
- The disc should be cleaned from the center to the edge.

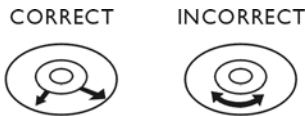

FROM THE CENTRE TO THE EDGE

- Never use benzene, thinners, record cleaner fluid or anti-static spray.
- Be sure to close the CD door, so the lens is not contaminated by dust.
- Do not touch the lens.

IMPORTANT NOTES

Your hearing is very important to you and to us so please take care when operating this equipment. It is strongly recommended that you follow the listed guidelines in order to prevent possible damage or loss of hearing.

ESTABLISH A SAFE SOUND LEVEL

- Over time your hearing will adapt to continuous loud sounds and will give the impression that the volume has in fact been reduced. What seems normal to you may in fact be harmful.
To guard against this **BEFORE YOUR HEARING ADAPTS** set the volume at a low level.
- Slowly increase the level until you can hear comfortably and clearly and without distortion.
- Damage to your hearing is accumulative and is irreversible.
- Any ringing or discomfort in the ears indicates that the volume is too loud.

Once you have established a comfortable listening level, **DO NOT INCREASE THE SOUND LEVEL FURTHER.**

The following list of typical sound levels may assist you in recognizing just how loud you have set the volume level.

DECIBEL

Level dB	Example
30dB	Quiet library, soft whisper.
40	Living room, fridge freezer bedroom away from traffic.
50	Normal conversation, quiet office, light traffic.
60	Electric sewing machine.
70	Vacuum cleaner, hair dryer, noisy restaurant.

THE FOLLOWING NOISE CAN BE HARMFUL UNDER CONSTANT EXPOSURE

80dB	Average city traffic, alarm clock buzzer at 2 feet, food mixer.
90	Motorcycle, heavy goods vehicle, petrol lawn mower.
100	Pneumatic drill, chain saw, garbage truck, discotec / night-club.
120	Rock band concert, thunderclap.

PERMANENT LOSS OF HEARING

140	THRESHOLD OF PAIN Gunshot 2 feet away.
180	Rocket Launching pad.

SPECIFICATIONS

GENERAL

Power Requirement	AC 230V~50Hz DC 12V UM-2 x 8 PCS
Power consumption	AC 20 Watts
Weight	Approx. 2.4kg
Dimension	Approx.364mm(L)x243mm(W)x141mm(H)
Operation temperature	+5° C - + 35 °C

RECEIVER SECTION

Receiving Bands	MW / FM
Tuning Range	MW 530 - 1600 KHz FM 88 - 108 MHz

COMPACT DISC SECTION

Optical Pickup	3-Beam Laser
Frequency Response	100Hz – 16 KHz

CASSETTE SECTION

Recording System	2 Tracks 2 channel (Stereo)
Biasing System	DC bias
Frequency Response	125 – 6.3 KHz
Wow and Flutter	0.35 % WRMS (JIS)

AUDIO SECTION

Power output	2 x 2.0 Watts (RMS)
Headphone Impedance	8 – 32 Ohm

ACCESSORIES

Instruction Booklet	
AC Cord	
Remote Handset	

Caution

- To avoid electric shock, this unit must not be exposed to dripping water splash.
Ventilation warning - Do not block the ventilation holes on this unit. Failure to do so may cause harm to this unit and is not covered under the warranty given



If at any time in the future you should need to dispose this product please note that Waste electrical products should not be disposed of with household waste. Please recycle where facilities exist. Check with your Local Authority or retailer for recycling advice. (Waste Electrical and Electronic Equipment Directive).

© 2007

www.goodmans.co.uk