

Goodmans

STEREO CD/RADIO/CASSETTE RECORDER WITH REMOTE CONTROL

GPS159R

Instruction Manual

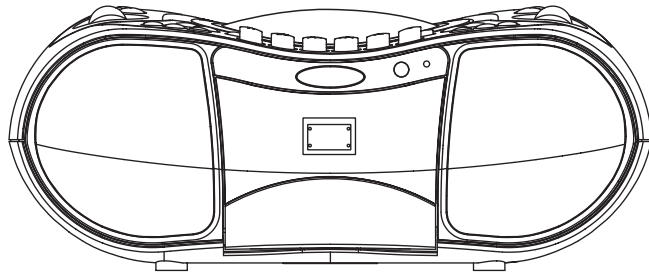

IMPORTANT SAFEGUARDS

PRE FITTED MAINS PLUGS

For your convenience a mains plug has been fitted to this appliance. For your safety please observe the following information.

1. Should the fuse in the plug fail, remove the plug from the wall socket and replace the fuse with a 3 Amp ASTA approved to BS 1362 fuse.
2. Never use the plug without the fuse cover fitted. Replacement fuse covers are available from your dealer or most electrical retail outlets.
3. If the mains plug is cut off the cable, rewire the replacement plug in accordance with instruction given in this manual.
4. CAUTION: Under no circumstances should the discarded plug be inserted mains socket. To prevent a shock hazard carefully dispose of the discarded plug. Do not leave the plug lying around where children might see it.

WARNING: To prevent fire or shock hazard do not expose this unit to rain or moisture.

CAUTION: DANGEROUS VOLTAGES EXIST INSIDE THIS UNIT, DO NOT REMOVE COVER (OR BACK). NO USER SERVICEABLE PARTS INSIDE. REFER SERVICING TO QUALIFIED SERVICE PERSONNEL. DISCONNECT FROM MAINS SUPPLY WHEN NOT IN USE.

PLUG WIRING DETAILS

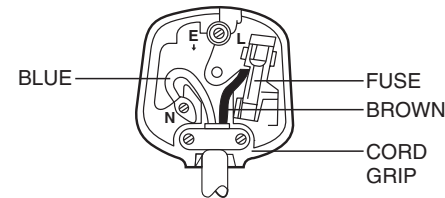

The wires in this mains lead are coloured in accordance with the following wiring codes:

Blue..... Neutral
Brown..... Live

The wires in this mains lead must be connected to the terminals in the plugs as follows:

Blue Wire..... N or Black
Brown Wire..... L or Red

Only a 3 Amp fuse should be fitted in the plug or a 5 Amp fuse at the distribution board.

WARNING: UNDER NO CIRCUMSTANCES MUST THE LIVE OR NEUTRAL WIRES BE CONNECTED TO THE EARTH TERMINAL IN A 3-PIN MAINS PLUG.



This symbol means that this unit is double insulated. An earth connection is not required.

CAUTION
CLASS 1 LASER PRODUCT

Use of Controls or adjustments or performance of procedures other than those specified herein may result in hazardous radiation exposure.

LASER SAFETY

This unit employs a laser, only qualified service personnel should attempt repair.



DANGER: INVISIBLE LASER RADIATION WHEN OPEN AND INTERLOCK FAILED OR DEFEATED. AVOID DIRECT EXPOSURE TO BEAM.

CAUTION: HAZARDOUS LASER RADIATION WHEN OPEN AND INTERLOCK DEFEATED.

CAUTION

CLEANING: Always disconnect unit from mains supply before attempting to clean it. Use soft cloth moistened with soapy water, wipe gently. Do not use solvents or abrasive materials.

SOME DO'S AND DONT'S ON THE SAFE USE OF EQUIPMENT

This equipment has been designed and manufactured to meet European safety standards but like any electrical equipment, care must be taken if you are to obtain the best results and safety is to be assured.

Do read the operating instructions before you attempt to use the equipment.

Do ensure that all electrical connections (Including the mains plug, extension leads and interconnections between pieces of equipment) are properly made in accordance with the manufacturer's instructions. Switch off and withdraw the mains plug when making or changing connections.

Do consult your dealer if you are ever in doubt of the installation, operating, or safety of your equipment.

Don't continue to operate the equipment if you are in any doubt about it working normally, or if it is damaged in any way- switch off, withdraw the mains plug and consult your dealer.

Don't remove any fixed covers as this may expose dangerous voltages.

Don't leave equipment switched on when it is unattended unless it is specifically stated that it is designed for unattended operation or has a standby mode. Switch off using the switch on the equipment and made sure that your family knows how to do this. Special arrangements may need to be made for infirm or handicapped people.

Don't listen to headphones at high volume, as such use can permanently damage your hearing.

Don't obstruct the ventilation of the equipment, for example with curtains or soft furnishings. Overheating will cause damage and shorten the life of the equipment.

Don't allow electrical equipment to be exposed to rain or moisture.

Above all

- Never let anyone, especially children, push anything into holes, slots or any other opening as this could result in a fatal electric shock.
- Never guess or take chances with electrical equipment of any kind.
- It is better to be safe than sorry!

WARNING: TO REDUCE THE RISK OF FIRE OR ELECTRIC SHOCK, DO NOT EXPOSE THIS APPLIANCE TO RAIN OR MOISTURE, DANGEROUS HIGH VOLTAGES ARE PRESENT INSIDE THE ENCLOSURE, DO NOT OPEN THE CABINET, REFER SERVICING TO QUALIFIED PERSONNEL ONLY.

IMPORTANT NOTES

Your hearing is very important to you and to us so please take care when operating this equipment. The following guidelines are provided for your information.

ESTABLISH A SAFE SOUND LEVEL

- Over time your hearing will adapt to continuous loud sounds and will give the impression that the volume has in fact been reduced. What seems normal to you may in fact be harmful. To guard against this **BEFORE YOUR HEARING ADAPTS** set the volume at a low level.
- Slowly increase the level until you can hear comfortably and clearly and without distortion.
- Damage to your hearing is accumulative and is irreversible.
- Any ringing or discomfort in the ears indicates that the volume is too loud.
- Remember listening for prolonged period of time at high volume levels will harm your hearing.

Once you have established a comfortable listening level, DO NOT INCREASE THE SOUND LEVEL FURTHER.

The following list of typical sound levels may assist you in recognizing just how loud you have set the volume level.

DECIBEL

<u>Level dB</u>	<u>Example</u>
30dB	Quiet library, soft whisper.
40	Living room, fridge freezer bedroom away from traffic.
50	Normal conversation, quiet office, light traffic.
60	Electric sewing machine.
70	Vacuum cleaner, hair dryer, noisy restaurant.

THE FOLLOWING NOISE CAN BE HARMFUL UNDER CONSTANT EXPOSURE

80dB	Average city traffic, alarm clock buzzer at 1 Metre, food mixer.
90	Motorcycle, heavy goods vehicle, petrol lawn mower.
100	Pneumatic drill, chain saw, garbage truck, discotec/night-club.
120	Rock band concert, thunderclap, fast train passing by.
140	THRESHOLD OF PAIN Gunshot, jet plane taking off.
180	Rocket Launching pad.

TABLE OF CONTENTS

Power Sources.....	1
Player Maintenance.....	2
Disc Cleaning, Power failure.....	3

Player Operation

Location of Controls.....	4
Radio operation.....	5
Listening to a compact disc.....	6
Program play operation.....	7
Repeat play operation.....	8
Automatic level control(ALC).....	9
DBBS (bass boost) function.....	10
Listening with headphone/earphone(Not Supplied)....	11
Cassettes.....	12
To record from the built-in radio, Microphone, compact disc.....	13
Remote control.....	14
Product Specifications.....	15

WARNING

To prevent fire or shock hazard, do not expose the unit to rain or moisture.

To avoid electrical shock, do not open the cabinet. Refer servicing to qualified personnel only.

SAFETY PRECAUTIONS

1. As the laser beam used in this compact disc player is harmful to the eyes, do not attempt to disassemble the casing.
2. Stop operation immediately if any liquid or solid object should fall into the cabinet. Unplug the unit and have it checked by qualified personnel.
3. Do not touch the lens or poke at it. If you do, you may damage the lens and the player may not operate properly.
4. Do not put anything in the safety slot. If you do, the laser diode will be ON when the lid is still opened.
5. This unit employs a laser. The use of controls or adjustments or performance of procedures other than those specified herein may result in exposure to hazardous radiation.

1. POWER SOURCES

AC MAINS

Insert the plug of AC power cord into wall outlet and the connector into the AC supply socket on the rear of the unit. Battery power will be disconnected automatically.

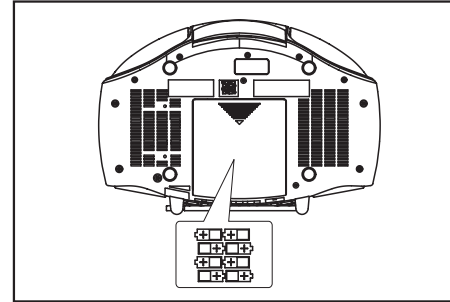

BATTERY OPERATION

Remove the Battery Compartment Cover and insert 8 pcs UM-2 (Size C) batteries, replace the cover.

NOTE: ENSURE BATTERIES ARE CORRECTLY INSTALLED OBSERVING THE POLARITY AS SHOWN.

NOTE: Old batteries may swell and leak. To avoid damage to your instrument, remove the batteries when the unit is to be stored for long periods of time, or if the batteries become exhausted (the Power Indicator will be faded if the batteries are exhausted). And if radio sound is low or distorted, your batteries probably need replacing.

2. PLAYER MAINTENANCE

CLEANING THE TAPE HEADS

Clean the heads frequently to remove dust and tape residue. Dirt on the heads will impair the sound quality of both recording and playback.

The simple method is to use a head-cleaning cassette, which is available at most audio stores. Follow the instructions supplied with the cleaning cassette.

3. DISC CLEANING, POWER FAILURE

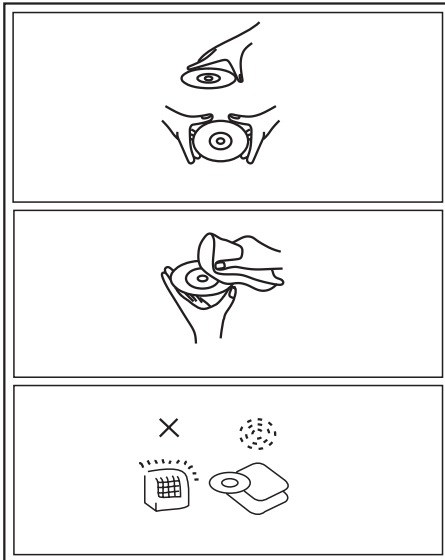

Cleaning the Disc

1. To handle a disc use only one of the two manners illustrated.

Note Do not touch the rainbow - coloured Side.

2. To wipe a disc, use only a soft cloth. Do not use petroleum based products or thinner which will damage the disc. The disc should always be wiped in a straight line from the center to the edge. It should never be wiped in a circular motion.
3. Never place the disc on other equipment or near any heat source. Avoid positions where the disc would be subjected to direct sunlight for long periods.

Maintenance and care

1. Electronic products should never be subjected to extreme temperatures nor high humidity to ensure good performance and a long life-time. The portable stereo should not be placed in bathing areas, or around stoves and radiators, etc. Always leave sufficient space around the unit for ventilation.
2. If necessary, only clean the cabinet of the unit with a soft dampened piece of cloth (be sure the AC power cord is unplugged from the outlet) Never use a polish or a strong detergent for cleaning since this can damage the finish of the cabinet.

4. LOCATION OF CONTROLS

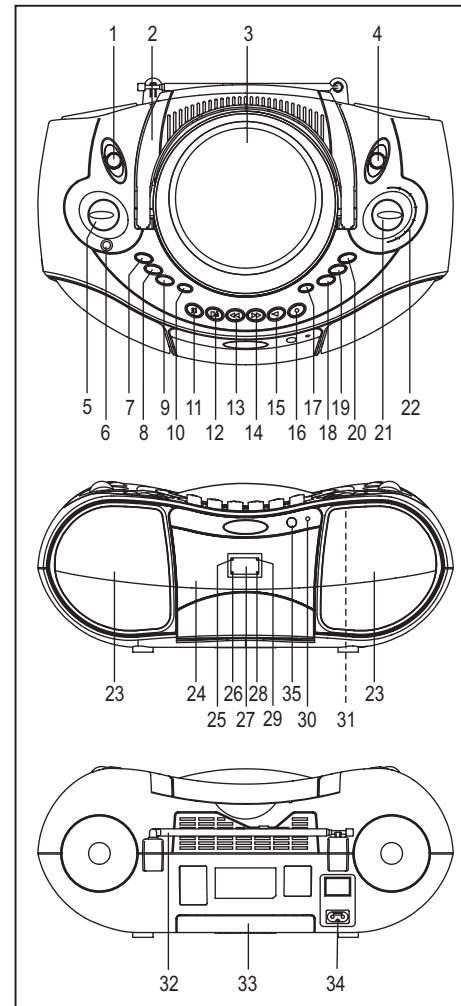

1. FUNCTION SWITCH
2. HANDLE(FOLDING)
3. CD DOOR
4. BAND SWITCH
5. VOLUME CONTROL
6. PHONES SOCKET
7. BASS BOOST BUTTON
8. CD PLAY/PAUSE BUTTON
9. CD STOP BUTTON
10. CD REPEAT BUTTON
11. CASSETTE PAUSE BUTTON
12. CASSETTE STOP/EJECT BUTTON
13. CASSETTE FAST FORWARD BUTTON
14. CASSETTE REWIND BUTTON
15. CASSETTE PLAY BUTTON
16. CASSETTE RECORD BUTTON
17. CD DOOR OPEN BUTTON
18. CD SKIP/SEARCH DOWN BUTTON
19. CD SKIP/SEARCH UP BUTTON
20. CD PROGRAM BUTTON
21. RADIO TUNING CONTROL
22. DIAL SCALE
23. SPEAKERS
24. CASSETTE DOOR
25. POWER INDICATOR
26. PROGRAM INDICATOR
27. LED DISPLAY
28. PLAY/PAUSE INDICATOR
29. REPEAT INDICATOR
30. FM STEREO INDICATOR
31. BUILT-IN MIC
32. FM TELESCOPIC AERIAL
33. BATTERY COMPARTMENT
34. AC SOCKET
35. REMOTE SENSOR

FOR REMOTE HANDSET

1. CD PLAY/PAUSE BUTTON
2. CD SKIP BACKWARD BUTTON
3. BATTERY COMPARTMENT
4. CD SKIP FORWARD BUTTON
5. CD STOP BUTTON

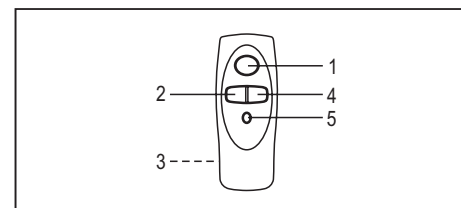

5. RADIO OPERATION

1. Slide the Function Switch to RADIO position.
2. Select the required wave band by sliding the Band Switch (FM or MW).
3. Rotate the Tuning Control in the appropriate direction until the desired broadcasting station is received.
4. For FM reception, adjust the Telescopic Aerial appropriately to obtain the best reception. For MW reception, rotate the unit to obtain the best reception.
5. Adjust the Volume Control as required.
6. If there is too much noise when receiving FM stereo broadcasting, adjust the Telescopic aerial.

NOTE: FM Stereo Indicator illuminates showing you are receiving a stereo broadcast.

If there is too much noise (hiss) when listening to a station in stereo, move the band switch from the FM ST. position to the FM position, the broadcast will then be received in mono.

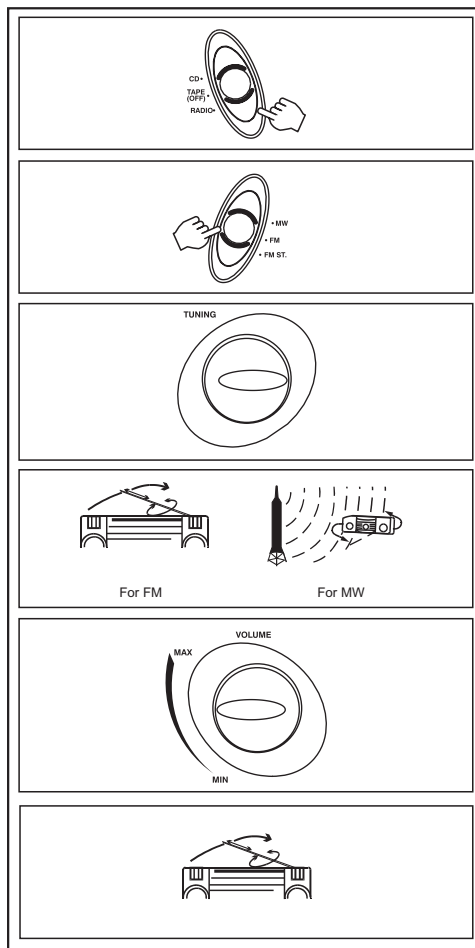

6. LISTENING TO A COMPACT DISC

LISTENING TO A COMPACT DISC

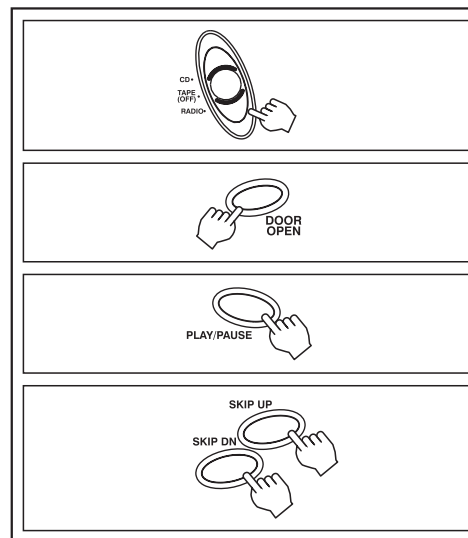

1. Slide the Function Switch to CD position.
2. Open the CD door by pressing Door Open Button to the lower right of the CD door.
3. Load the DISC with the label up.
 - Do not touch the playback side.
 - Centre the disc.
 - Do not touch the lens.
4. Close the lid, the disc will rotate and the LED Display will show the disc's total number of tracks.
5. Press the CD Play/Pause Button.
 - Press once to start playback from the first track. CD Play/Pause Indicator will illuminate.
 - Press again to pause playback, CD Play/Pause Indicator will flash.
 - Press the CD Forward Skip/Search Button (▶▶) to skip to the next track on the disc.
 - Press the CD Backward Skip/Search Button (◀◀) to skip to the beginning of the track currently playing.
 - Press the CD Backward Skip/Search Button (◀◀) again to skip to the previous track.
 - Press and hold the CD Backward or Forward Skip/Search Button (◀◀ or ▶▶) during playback to search backwards or forwards at high speed. When the desired section of the track is found, release the button, normal playback will resume.

7. PROGRAMME PLAYBACK

TO PROGRAM PLAY

1. Press the CD Stop Button during playback. The total number of tracks will be shown in the display.
2. Press the CD Program Button, "01" and Program Indicator will flash in the display.
3. Select the desired track by pressing Backward or Forward Skip/Search Button (◀◀ or ▶▶).
4. Press CD Program Button again to store the track in memory.
5. Repeat steps 3 and 4 (up to 20 tracks can be stored in memory).
6. After all tracks have been programmed, press the CD Play/Pause Button to start the playback from the first programmed track, the CD Play/Pause Indicator will illuminate and, the Program Indicator will stop flashing.

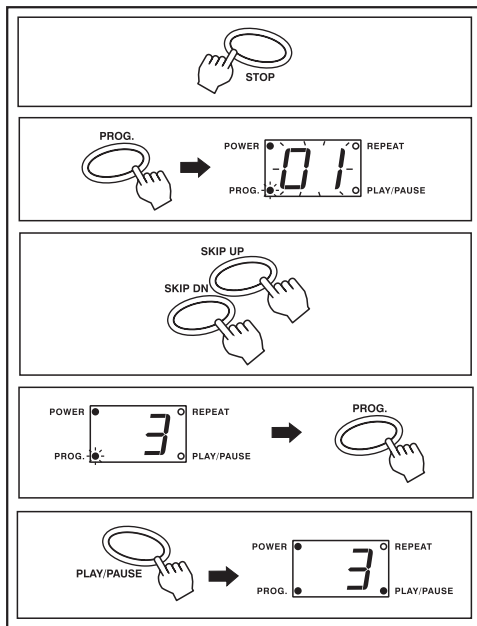

TO CLEAR PROGRAM

1. Press the CD Stop Button twice during programmed playback to clear the program.
2. With the unit in CD stop mode, press the Door Open Button to open the CD compartment, the program will be erased.

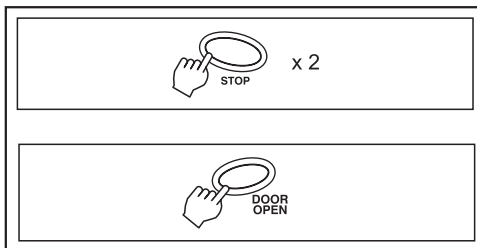

8. REPEAT PLAY OPERATION

SINGLE REPEAT

1. Press the CD Repeat Button once during playback. CD Repeat Indicator will flash.
2. Press the CD Backward or Forward Skip/Search Button (◀◀ or ▶▶) to select the desired track.
3. The track selected will be played over and over again until the CD Stop Button is pressed.
4. To cancel press the Repeat Button repeatedly until the Repeat Indicator is extinguished.

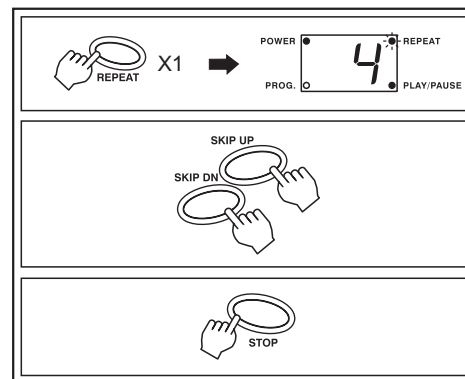

ALL TRACKS REPEAT

1. Press the CD Stop Button and total track number appears in the display.
2. Press the CD Repeat Button twice, CD Repeat Indicator will illuminate.
3. Press the CD Play/Pause Button, CD Play/Pause Indicator will illuminate, and all tracks will be repeated continuously until the CD Stop Button is pressed.
4. To cancel the repeat function, press the repeat button until the repeat indicator is extinguished.

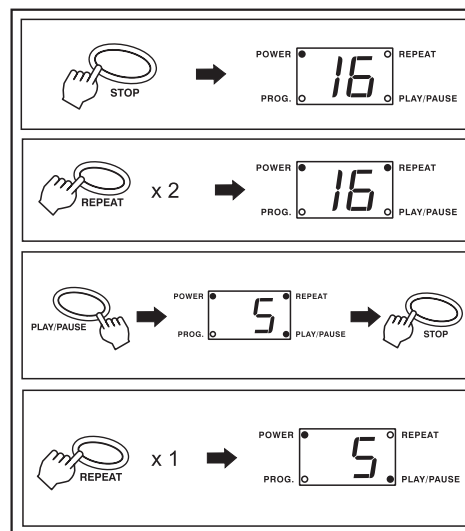

9. AUTOMATIC LEVEL CONTROL (ALC)

This product utilizes Automatic Level Control circuitry, therefore, it is not necessary to adjust the Volume Control when recording. This circuit automatically records at the correct level and prevents over loading.

NOTE: While recording the Volume Control may be adjusted as desired without affecting the recording operation.

10. BASS (BASS BOOST) FUNCTION

To enhance the bass performance when listening at low volume press the DBBS button. Press the button again to switch the function off.

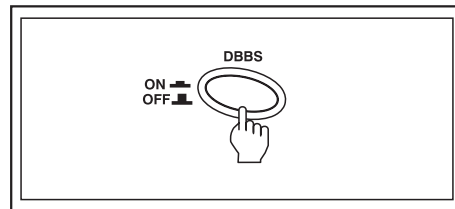

11. LISTENING WITH HEADPHONE/EARPHONE (NOT SUPPLIED)

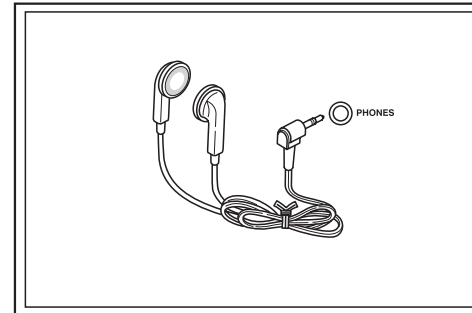

For private listening without disturbing others, headphones/earphones can be used, set the Volume Control to minimum level, plug the headphone/earphone into Phones socket, adjust the Volume Control as required. When headphones are connected the audio to the unit speakers will be automatically muted.

CAUTION: Listening at high power for a long periods could damage your hearing.

12. CASSETTE OPERATION

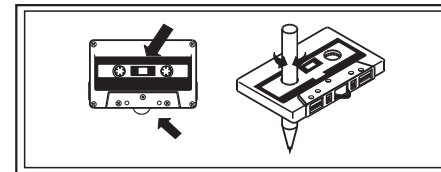

CASSETTE TAPE SELECTION

1. The quality and condition of the cassette tapes used will have a direct effect on the performance of this unit. Low quality tapes tend to stretch, and a stretched tape can easily become entangled in the drive mechanism, causing major damage. Stretched tapes will run at uneven speeds and will distort anything recorded on them.
2. Use only well known brands of tape.
3. Use of C-120 (120 minutes) cassettes are not recommended. The extreme thinness of this tape may result in breakage or other problems.
4. Check to ensure there are no loose layers of tape visible through the cassette center window. Tighten these loose layers with a pencil or ballpoint pen before inserting the cassette into the unit.

NORMAL PLAYBACK

1. Slide the function selector to TAPE.
2. Press the STOP/EJECT key to open the cassette compartment and insert a pre-recorded tape with the exposed portion of the tape facing uppermost and the full spool to the right. Gently push the door to close.
3. Press the PLAY key to start playback, adjusting the VOLUME to the desired level.
4. To briefly pause playback press the PAUSE key, press again to resume normal playback.
5. To advance or rewind the tape rapidly press the FAST FORWARD or REWIND keys.
6. To stop playback press the STOP/EJECT key, press again to EJECT the cassette.

NOTE: When the cassette reaches its end during playback or recording, the mechanism will stop and the keys will return to their normal position.

13. TO RECORD FROM THE BUILT - IN RADIO, MICROPHONE, COMPACT DISC

RECORD FROM THE RADIO

1. Follow the instructions of RADIO OPERATION to tune to the desired station.
2. Ensure the function switch is in the radio position.
3. Load a blank cassette tape into the Deck. (Full spool to the right)
4. Locate the portion of the tape where recording is to start by using Rewind or Fast Forward.
5. Press the Record and Play simultaneously. Both keys will remain in the down position.
6. The set is now recording from the Radio, the recording process will automatically stop at the end of the tape.
7. To stop the recording manually, press the Stop/Eject Key.

NOTE: To hear what has been recorded , slide the function switch to the TAPE position, press the rewind key to rewind the tape to the point where the recording was started, then press the Play key to start playback. Adjust the volume control as required.

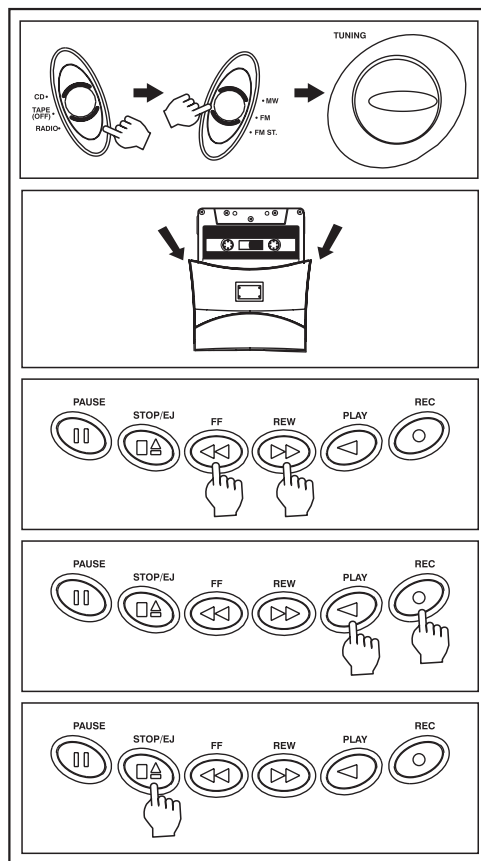

RECORD FROM THE BUILT - IN MICROPHONE

1. Slide the Function Switch to TAPE position.
2. Load a blank cassette tape into the Cassette Compartment with full spool to the right.
3. Press the Play and Record keys simultaneously. Both keys will remain in the down position.
4. Speak or talk in front of the unit. You are now recording from the Built-In Microphone and the recording process will automatically stop at the end of the tape.
5. To stop the recording manually, press the Stop/Eject.
6. To hear what has been recorded , slide the function switch to the TAPE position, press the rewind key to rewind the tape to the point where the recording was started, then press the Play key to start playback. Adjust the volume control as required.

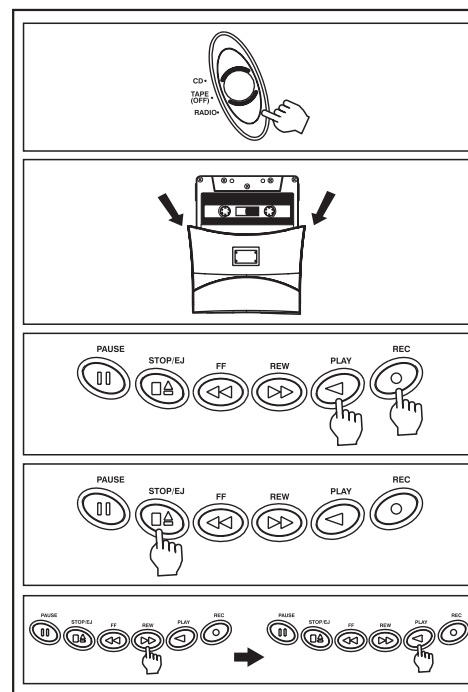

RECORD FROM COMPACT DISC

1. Load a cassette tape into the cassette compartment.
2. Load the disc and close the CD Door.
3. Slide the Function Switch to CD position.
4. Press the Cassette Pause.

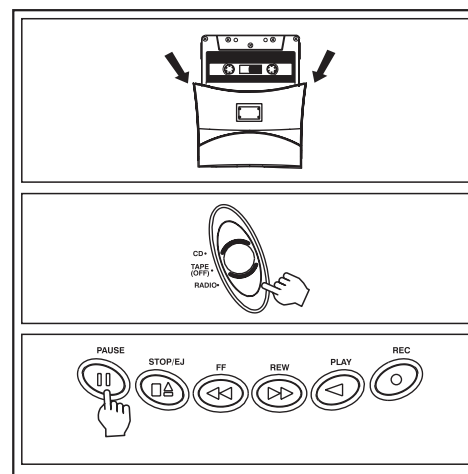

- Press the Cassette Record and Play Keys for recording stand-by.
- Start the CD playing by pressing the CD Play/Pause button.
- Release the Cassette Pause Key to start recording.
- Press the Cassette Stop/Eject Key to stop the recording.
- To Hear what has been recorded, slide the function switch to the TAPE position, press the rewind key to rewind the tape to the point where the recording was started, then press the Play key to start playback. Adjust the volume control as required.

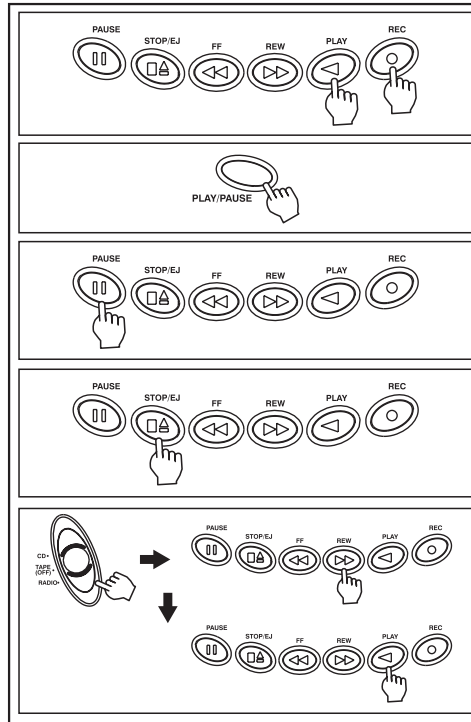

14. REMOTE CONTROL

REMOTE OPERATION

By using the remote controller, you can operate the system in almost the same way as with the controls of the main unit.

REMOTE CONTROL RANGE

Use the remote control within an angle of 30° at the left and right horizontally and over distances up to about 3 meters.

INSERTING BATTERIES

- Open the battery compartment cover.
- Install 2pcs UM-4 (size AAA) batteries into the battery Compartment matching the polarity as shown in the battery compartment.
- Close the battery compartment lid.

NOTE: Always remove batteries if the remote controller is not going to be used for a month or more. Batteries left in the unit may leak and cause damage.

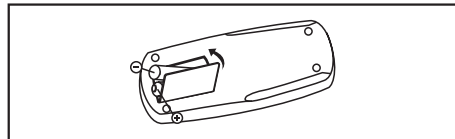

15. PRODUCT SPECIFICATIONS

PICK-UP

System	Compact disc digital audio system
Laser diode	material: GaAlAs
Properties	Wavelength: 780nm Emission duration: continuous Laser output level 44.6uW
Error correction	Cross-interleave Reed-solomon code

AUDIO

D/A conversion	1-bit DAC 8 times oversampling
Frequency response	20-20,000Hz (+1/-3 dB)
Wow and flutter	Below measurable limits
No. of channels	2 channels (stereo)
Output level of earphones	20mW * 2
Main speakers	3W/8 Ohms * 2

RADIO

Receiving bands	MW/FM
Frequency range	MW 540 - 1600 KHz FM 88 - 108 MHz

GENERAL

Power requirements	AC 230V/50Hz
Power consumption	13W
Dimension	Approx. 344 (L) x 237.5 (W) x 136 (H) mm
Weight	Approx. 2.278kg(Without batteries)

Please note: Due to the continual improvement of our products, specifications are subject to change without notice.